



Document	Installation Manual and User Manual for BYD		Project No.	\
Code	2M SOP0007540	Edition	13	Page
				1 / 20

Document Issue or Modification Record

Edition	Date	ECN code	Modification content	Writed or modified
1	2013-02-05	/	/	Mingguang Wang, Yingying Xu, Qin Cang
2	2013-08-08	/	Add Shangluo Factory	Xu Yingying
3	2013-09-27	/	Modify manufacturer name and address	Xu Yingying
4	2014-5-16	/	a,Modify the explain of bar code; b,Modify the installation picture c,Add the Parameter of Modules d, Canceled information of manufacturer	Fang Shuili, Han Peng
5	2014-9-5	/	Add manufacturer location	Fang Shuili
6	2015-3-5	/	Add Vietnam Factory	Han Peng
7	2015-8-28	/	Add Insertion system on the short side of the frame	HanPeng, BaoWei
8	2016-06-01	/	Increasing the power level of the model	HanPeng
9	2016-06-15	/	Modify naming PV modules	HanPeng
10	2016-09-29	/	Add new frame of the P6-18	HanPeng
11	2016-11-03	/	Add information of 1500V system Voltage of module and delete some low power modules	ZhaoBishuai
12	2016-2-10	/	Add information of 1100V system Voltage of module	ZhaoBishuai
13	2017-4-5	/	a. Add Runda factory; b. Modify module cleaning.	Li Chao, Yuan Shuyun, Cheng Yaru



Document	Installation Manual and User Manual for BYD		Project No.	\	
Code	2M SOP0007540	Edition	13	Page	2 / 20

14	2017-11-29	/	a. Add half-cell module b. Modify cleaning pressure c. Add installation height of module	Zhao bishuai Mao yonghua
15	2017-12-20	/	Add an equation for calculating the voltage of sting	Li Shangkun
16	2018-5-23	/	a. Modify power for P6K module b. Add PHK-30 module's power c. Add MHC-36 module's power d. Add MHK-36 module's power e. Add Santaicheng factory f. Add IEC 61215 new standard for load	Zhao bishuai



Document	Installation Manual and User Manual for BYD		Project No.	\	
Code	2M SOP0007540	Edition	13	Page	3 / 20



Installation Manual and User Manual for BYD Photovoltaic Modules

BYD COMPANY LIMITED.

ADD: Yan An Road, Kuichong,
Longgang, 518119 Shenzhen,
PEOPLE'S REPUBLIC OF
CHINA

TEL:+86-755-8988 8888

FAX:+86-755-8420 2222

www.byd.com.cn



Document	Installation Manual and User Manual for BYD			Project No.	\
Code	2M SOP0007540	Edition	13	Page	4 / 20

CONTENT

Foreword	5
1. Product identification	5
1.1 <i>Label</i>	5
1.2 <i>Barcode</i>	5
2. Transportation and storage manual	6
3. Installation	6
3.1 <i>Warning</i>	6
3.2 <i>Mechanical installation</i>	8
3.2.1 Mounting system	8
3.2.2 Clamping	10
3.2.3 Insertion system	12
3.3 <i>Electric installation</i>	14
3.3.1 Grounding.....	14
3.3.2 General Installation	15
4. Maintenance and Care	17
4.1 <i>General Maintenance</i>	17
4.2 <i>Module Cleaning</i>	18
5. Claim	20



Document	Installation Manual and User Manual for BYD		Project No.	\	
Code	2M SOP0007540	Edition	1	Page	5 / 20

1.2 Barcode

Foreword

This manual describes the transportation, installation and maintenance of PV modules (hereafter referred to as “module”). Please read this manual carefully before installing and using the modules. Please get in touch with the provider if you have any questions.

This manual applies to all the standard modules of BYD Company Limited.

Keep this guide in a safe place for future reference (care and maintenance) and in case of sale or disposal of the modules.



NOTE: All statements in this manual refer to our 3 or 4bus-bar polycrystalline cell PV modules .The illustrations in this manual, which show 2 or 3 bus-bar cell PV modules, are only used for reference purposes.

1. Product identification

1.1 Label

The label shows the product type, rated power, rated current, rated voltage, open circuit voltage, short circuit current, weight, dimensions etc.;

Each module has only one bar code as shown below:



FIG.1 Bar code

SH 130701 P630 ASEC 001

SH——Manufacturer location, SH:Shanghai; SA:South Africa
SL:Shangluo; TS:Tangshan Haitai; VN:Vietnam; RX:Ruixin; BR:Brazil;
RD:Runda; GL:Guolong (Dingxinsheng) ;ST:Santaicheng;

130701——Date (YYMMDD) ;

P——P for Poly -Si, M for Mono-Si; L for Mono-like

6——6 for the cell dimension of 156*156, 5 for the cell dimension of 125*125mm, 7 for the cell dimension of 156.75*156.75; H for the cell dimension of 156.75*78.375mm

30——the voltage of the modules;

ASEC- ——Engineering Code ,for different shifts, materials etc;

001——Number of product components,3 digit sequence 0 to 999 for sequential production starting on each new day of production at 001.



Document	Installation Manual and User Manual for BYD		Project No.	\	
Code	2M SOP0007540	Edition	13	Page	6 / 20

2. Transportation and storage manual

Please observe the following criteria after packing:

- (1) Don't tilt the packing boxes for more than 15° during handing.
- (2) Please follow the instruction labels "up" and "down" during placing the packing boxes and avoid placing them upside down during transit.
- (3) Be careful while handing the boxes during transit, and avoid heavy pressure or jolting of the boxes.
- (4) The packing boxes should be protected from rain.
- (5) Transportation conditions should conform to the requirements of the packing boxes and of the modules regarding their environmental conditions.

3. Installation

3.1 Warning

- (1) Do not use mirrors or other magnifiers to artificially concentrate sunlight on the module.
- (2) Do not touch the connectors with bare hands and use insulated tools during electrical work.
- (3) Although the glass surface of the modules is rather durable and able to withstand pressure, the glass might break (and the module will

no longer work properly), if it is dropped or hit by tools or other heavy objects.

(4) Under certain conditions, the module might produce a higher electric current and/or voltage than measured under standard test conditions. Accordingly, the values of I_{sc} and V_{oc} marked on this module should be multiplied by 1.25 when determining the component voltage ratings, conductor current ratings, fuse sizes and size of controls relating to the PV output.

(5) The installation work of the PV array can only be done under the protection of sun-sheltering covers or sunshades, and only qualified persons should install modules or perform maintenance work.

(6) Systems should be installed by qualified personnel only and at least by two persons. The system involves electricity and can be dangerous if the personnel are not familiar with the appropriate safety procedures.

(7) Follow the recommendations of the battery manufacturer if batteries are used with the modules. Please observe national and local laws and regulations when installing modules. If required, an architecture license should be obtained before carrying out this work.

(8) Please unpack carefully.

(9) A visual inspection should be carried out before installation, in order to make sure that there is no defect in the packing, the junction box or on the surface of module.

(10) The user should design and select a metallic bracket for installing that is suitable to bear the weight of the PV modules. The



Document	Installation Manual and User Manual for BYD		Project No.	\
Code	2M SOP0007540	Edition	13	Page
				7 / 20

brackets should be selected by the user according to their destined places of installation, such as open land or a rooftop. For safety reasons, all brackets should be grounded. In order to insure good conductivity, electroplated brackets should be used.

(11) As a general rule, PV modules should be installed in a location where they will receive maximum sunlight throughout the year. In the Northern Hemisphere, the modules should typically face south, and in the Southern Hemisphere, the modules should typically face north. When choosing a site, avoid trees, buildings or other obstructions, which might block the sunrays. When selecting a clamping or insertion system, appropriate anticorrosive brackets should be selected according to the specification of the module.

(12) Put the modules on the frame and tighten the screws after putting on the underlying washers. Don't cover the drain holes with other components when installing the modules. The junction box should be placed at the top of the module in order to facilitate correct positioning of ventilation holes.

(13) Don't grasp the junction box or cables during the installation process.

(14) In case of installing the module on a roof top, the roof top should be made fire-resistant first. Do not use modules near equipment or in places where flammable gases may be generated.

(15) In case of roof top installation, the PV array should fulfill the requirements regarding fire resistance of the norm IEC 61730-2.

(16) The ambient temperature range at the location of installation

should not exceed -40°C ~+85°C.

(17) Do not connect/disconnect modules during load connection.

(18) If the modules are installed on the roof, the whole system mounting should be installed around 20CM away from the roof. The recommended standoff height is 20 cm. The PV array installation slope should more than 5in/ft (127mm/305 mm) when modules are installed in rooftop. The module is in a minimum fire resistance rating of Class C, and the fire rating of this module is valid only when mounted in the manner specified in the mechanical mounting instructions.

(19) If the component is installed on the roof, the structure must have a high bearing capacity, common roof structure such as color steel roofs, cement flat roofs, the glazed tile roof, etc.

(20) If the modules have the area of the salt crystals which exceed 5% of the modules on façade then should clean it up. We advice that the modules should cleanly at every turn.

(21) We suggested that the height of the module from the ground is not less than 60cm, in order to prevent the hot –spot caused by the weeds.



DANGER: One single module may generate more than 30V DC when its front is exposed to direct sunlight. If modules are connected in series, the total voltage is equal to the sum of the partial voltages of each module .A nominal open voltage or maximum system voltage of 45 V or more may cause an electric shock, exist in the conspicuous position of a module connection part. Therefore direct contact should be





Document	Installation Manual and User Manual for BYD		Project No.	\	
Code	2M SOP0007540	Edition	13	Page	8 / 20

avoided after installing a greater number of modules in series or parallel, in order to avoid electric shocks.



CAUTION: Please unpack the module in an appropriate environment, and use special tools. The modules need to be kept water-proof and damp-proof.

NOTE: BYD does not limit the materials of the installation as long as they can be used outdoors for at least 25 years

3.2 Mechanical installation

3.2.1 Mounting system

Use screws put through the mounting holes according to the following figure for fixing the module, If all mounting holes are used, a load of 3600Pa for frontal, a load of 1800Pa for back (IEC61215 2016 safety factor 1.5).

Description of the mounting holes:

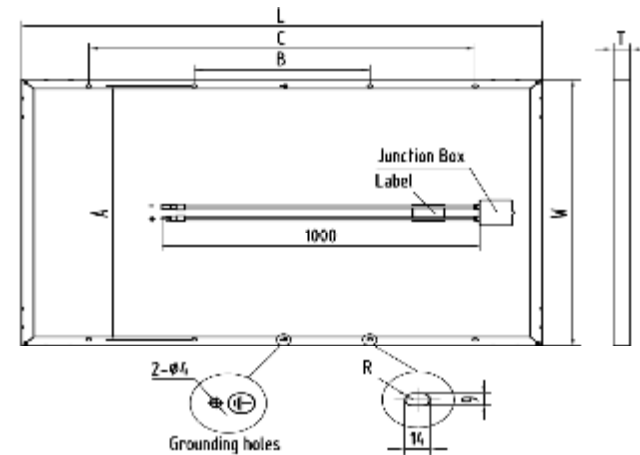

FIG.2 P6K series models

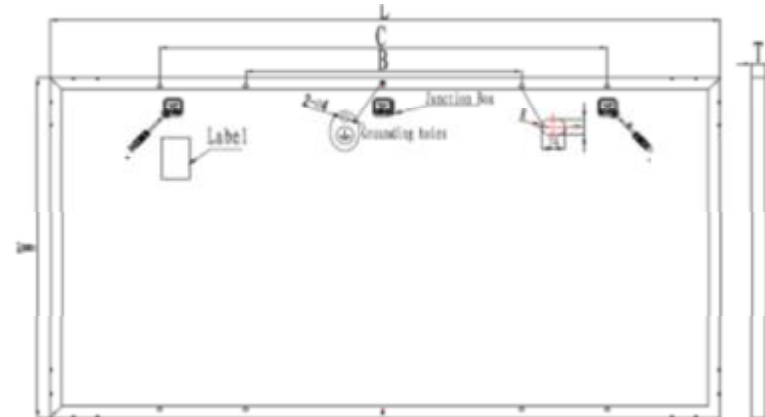

FIG.3 PHL series models



Document	Installation Manual and User Manual for BYD		Project No.	\
Code	2M SOP0007540	Edition	13	Page
				9 / 20

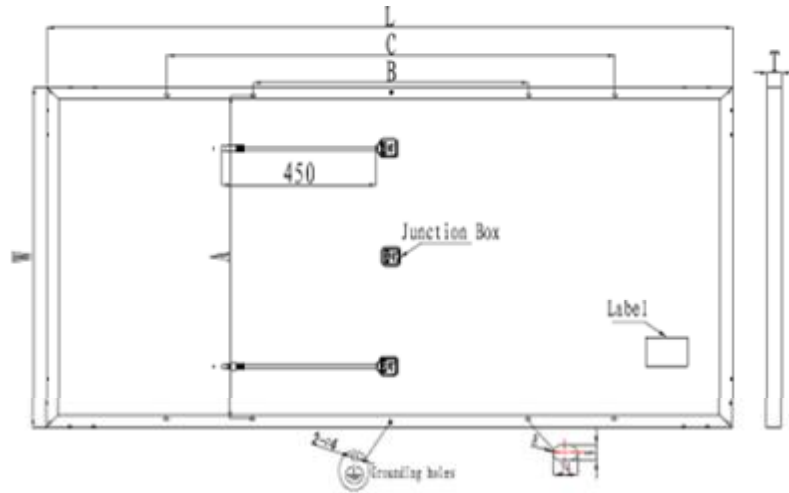

FIG.4 PHK series models

5

TAB.1 The size of each code

measure / Model	L	W	T	A	B	C
BYDxxxP6K-18	1482	676	50/40/35	626/628	802/482	566
BYDxxxM6K-18						
BYDxxxP6K-24	1325	992	50/40/35	942	476	1076
BYDxxxP6K-27	1482	992	50/40/35	942	500	1100
BYDxxxP6K-30	1640	992	50/40/35	942	860	1360
BYDxxxM6K-30						
BYDxxxP6K-30	1645	992	45/40/35	942	860	1360
BYDxxxM6K-30						

BYDxxxPHK-30	1658	992	40/35	942	860	1360
BYDxxxMHK-30						
BYDxxxPHK-30	1669	992	50/40/35	942	860	1360
BYDxxxMHK-30						
BYDxxxP6K-36	1956	992	50/40/35	942	800	1300
BYDxxxM6K-36						
BYDxxxP6K-36	1962	992	45/40/35	942	800	1300
BYDxxxM6K-36						
BYDxxxPHK-36	1992	992	50/40/35	942	800	1300
BYDxxxMHK-36						
BYDxxxPHK-36	1978	992	40/35	942	800	1300
BYDxxxMHK-36						
BYDxxxPHL-36	1948	1022	50/40/35	972	800	1300

Remark: The P6K-18 have two mounting hole arrangements. One have four Mounting holes, The other have eight Mounting holes. "K" denotes 1500V system Voltage of module, "L" denotes 1500V system Voltage of half-cell transverse module.

During installation of the modules it should be made sure, that all mounting holes are used for fixation, the number of mounting holes for each module series is indicated in the table below:

TAB.2 Number of mounting holes for each series of components



Document	Installation Manual and User Manual for BYD		Project No.	\
Code	2M SOP0007540	Edition	13	Page
				10 / 20

Model measure	n	Model measure	n
BYDxxxP6K-18		BYDxxxPHK-30	8
BYDxxxM6K-18		BYDxxxMHK-30	
BYDxxxP6K-24	8	BYDxxxP6K-36	
BYDxxxP6K-27		BYDxxxM6K-36	
BYDxxxP6K-30		BYDxxxP6K-36	
BYDxxxM6K-30		BYDxxxM6K-36	
BYDxxxP6K-30		BYDxxxPHK-36	
BYDxxxP6K-30		BYDxxxMHK-36	
BYDxxxM6K-30		BYDxxxPHK-36	
BYDxxxPHK-30		BYDxxxMHK-36	
BYDxxxMHK-30			

- 1) Aluminum Frame
- 2) M8 Stainless Bolt M8
- 3) Flat Stainless Washer
- 4) Spring Stainless Washer
- 5) HEX Stainless Nut

3.2.2 Clamping

For clamping of the modules, clamps can be used as in the figure below, while the clamps must be strong enough to fasten the modules (the use of stainless steel is recommended), and their structure must not cover the cells. A load of 3600Pa for frontal, a load of 1800Pa for back(IEC61215 2016 safety factor 1.5).

If a module is installed with clamps on a long side of the frame, "B" denotes the possible clamping range:

Installation details:

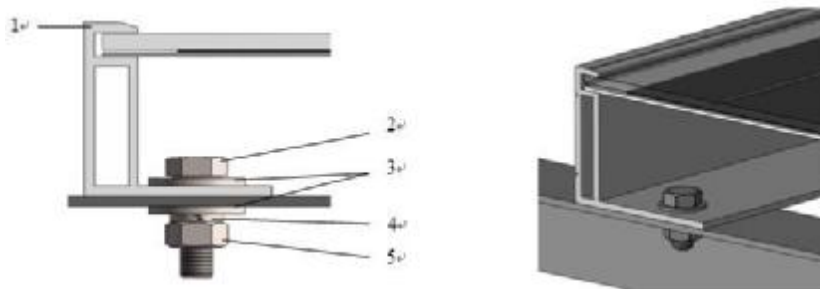

FIG.5 Diagram of pressure installation

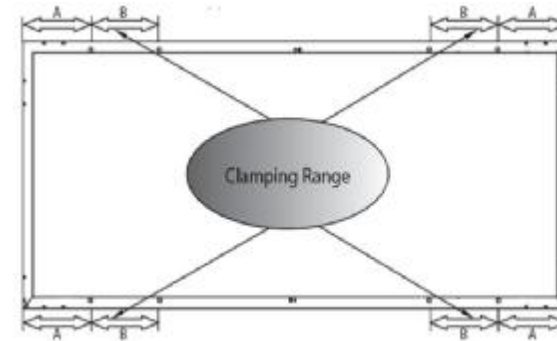

FIG. 6 Installation diagram of four fixtures

TAB. 3 The dimensions corresponding to fixture installation



Document	Installation Manual and User Manual for BYD		Project No.	\
Code	2M SOP0007540	Edition	13	Page
				11 / 20

Model	Measure A	Measure B
BYDxxxP6K-18	120	250
BYDxxxM6K-18		
BYDxxxP6K-24	110	250
BYDxxxP6K-27	120	250
BYDxxxP6K-30 (L=1640)	140	250
BYDxxxM6K-30 (L=1640)		
BYDxxxP6K-30 (L=1650)	145	250
BYDxxxM6K-30 (L=1645)	142.5	250
BYDxxxP6K-30 (L=1645)		
BYDxxxPHK-30 (L=1669)	158	250
BYDxxxMHK-30 (L=1669)		
BYDxxxPHK-30(L=1658)	149	250
BYDxxxMHK-30(L=1658)		
BYDxxxP6K-36(L=1956)	328	250
BYDxxxM6K-36(L=1956)		
BYDxxxP6K-36(L=1962)	331	250
BYDxxxM6K-36(L=1962)		
BYDxxxPHK-36(L=1992)	346	250
BYDxxxMHK-36(L=1992)		
BYDxxxPHK-36(L=1978)	339	250
BYDxxxMHK-36(L=1978)		

Remark: "A" denotes the distance from the clamp to the edge of the module, while "B" denotes the possible clamping range.

Installation method:

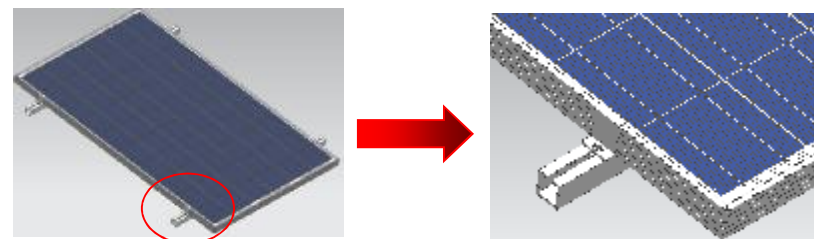

FIG. 7 Schematic diagram of long side pressing block

We advise users to use an installation method as shown in the two pictures above, as this method renders modules connection rather fast.

Installation method with clamping on the short side of the frame as below:

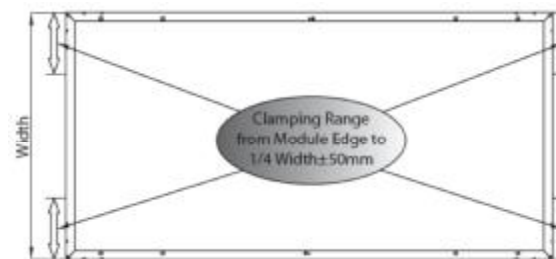

FIG. 8 Schematic diagram of four clamps

Installation method:



Document	Installation Manual and User Manual for BYD		Project No.	\	
Code	2M SOP0007540	Edition	13	Page	12 / 20

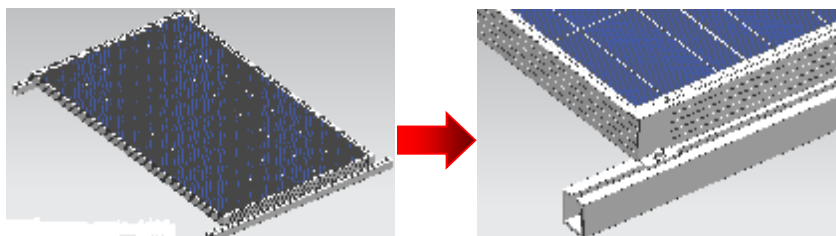

FIG. 9 Schematic diagram of short side pressing block



Notice: If customer choose Installation method with clamping on the short side of the frame, you should customize the length of the electric cable for us.

3.2.3 Insertion system

For the modules to follow an insertion system as depicted below can be used for installation. The insertion system must have enough strength to fix modules, and can be made of materials such as stainless steel and other appropriate metals for solid support of the PV modules.

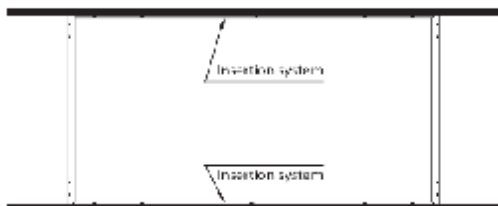

FIG. 10 Installation diagram of long side guide rail

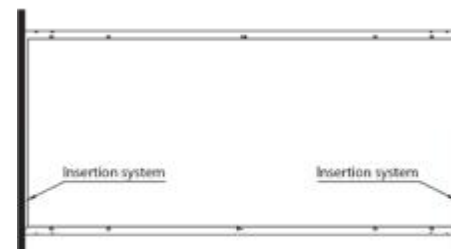

FIG. 11 Guide rail installation diagram

During the installation on the long side of the frame you need to take care that the cells on the front side and that the grounding holes on the back side don't get covered. Please refer to the detailed illustration below for installation on the long side of the frame:

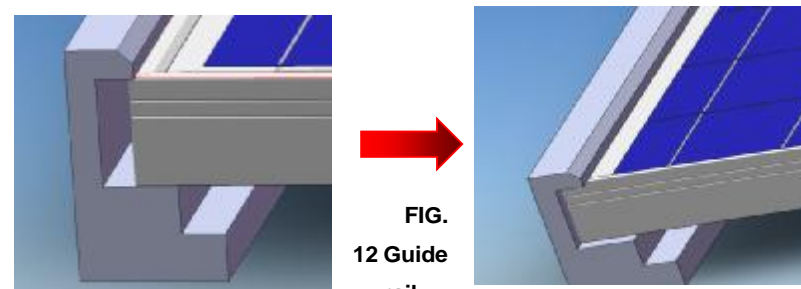
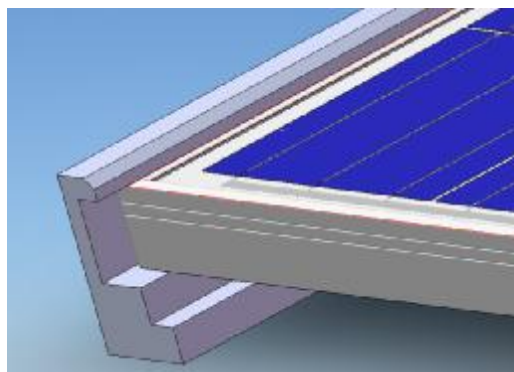

FIG. 12 Guide rail



Document	Installation Manual and User Manual for BYD		Project No.	\
Code	2M SOP0007540	Edition	13	Page
				13 / 20



installation diagram

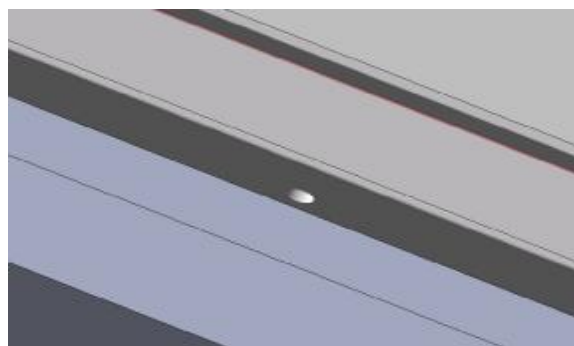

FIG. 13 The front cannot block the PV plate and the back cannot block the grounding hole

The installation mode of the half-cell intermediate outgoing module is recommended the long edge to be parallel the ground; The installation mode of the half-cell long edge outgoing module is recommended the short edge to be parallel the ground.

All the mounting ways above are suitable to roof mounting. And the module is considered to be in compliance with IEC61215 when the module is mounted in the manner specified by the mounting instruction above.

Tab 4. List of mounting modes with border thickness

Thickness \ Installation	50mm	45mm	40mm	35mm	30mm	Refer
Long side bolt	✓	✓	✓	✓	✓	FIG.2 FIG.3 FIG.4 FIG.5
Long side press	✓	✓	✓	✓	✓	FIG.6 FIG.7
Long side rail	✓	✓	✓	✓	✓	FIG.10 FIG.12 FIG.13
Short side	✓	✓	✓	✗	✗	FIG.8



Document	Installation Manual and User Manual for BYD		Project No.	\	
Code	2M SOP0007540	Edition	13	Page	14 / 20

press						FIG.9
Short side rail						FIG.11
	√	√	√	×	×	FIG.12
						FIG.13

Note: √ : Indicates compliance with load bearing installation requirements; X: indicates that the load bearing installation requirements are not met

3.3 Electric installation

3.3.1 Grounding

(1) Grounding: For safety reason, all module frames should be prepared for grounding. It is not recommended to use modules with different configurations (grounding, wiring) in the same system. The connecting areas between the materials of the frame and the grounding should not cause galvanic corrosion.

(2) Regarding grounding and bonding requirements, please refer to regional and national safety and electricity standards. If grounding is required, use a recommended connector type, or an equivalent, for the grounding wire. The grounding wire must be properly fastened to the module frame to assure adequate electrical connection.

(3) There are many possible methods for grounding. The main point

is to ensure the resulting safety. We recommend one method as sketched below:

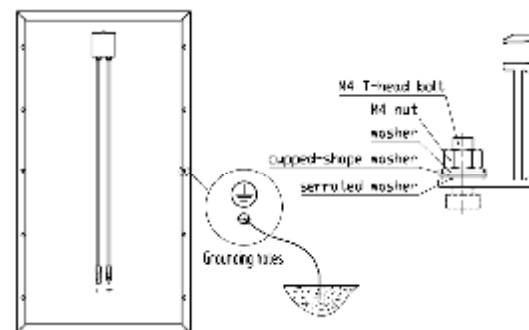

FIG. 14 Ground diagram

(4) All module frames should be grounded for safety. All materials for grounding connections between modules must be approved by a qualified electrician and also, the grounding itself must be done by a qualified electrician. The ground wire should have at least the same size as the electrical conductors (10-12 AWG exposed copper wire with a minimum of 90°C is recommended).

(5) In order to avoid potential induced degradation (PID), BYD insists that the negative electrode of the inverter should be grounded.



CAUTION: BYD modules provide the mounting holes, drain holes and grounding holes. That has passed the safety testing. Installers can't drill and block drain holes at random.



Document	Installation Manual and User Manual for BYD		Project No.	\	
Code	2M SOP0007540	Edition	13	Page	15 / 20

3.3.2 General Installation

(1) The module was rated for use in the A application class which follows the items referred in IEC 61730-1. When the modules in a PV system are connected in series or parallel generally, we recommend simple methods of connecting them in series or parallel as shown below:

Series connection of modules:

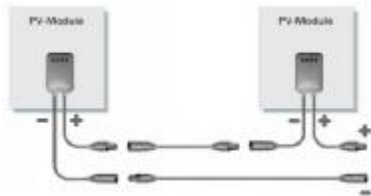

Parallel connection of modules:

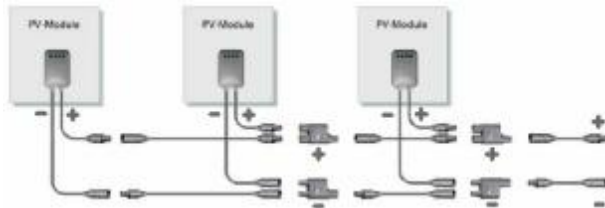

(2) The bypass diode should have a Rated Average Forward Current at least 10A, and a Rated Repetitive Peak Reverse Voltage of at least 40V. The diode types are as below:

Type	Maximum DC Blocking Voltage	Maximum Average Forward Current
20SQ045	45V	20A
10SQ050	50V	10A
GF2045MG	45V	20A
SDA2040	40V	20A

(3) The cable must not be bent or crushed on the direct exit of the cable screw joint include connector and box. A minimum bending radius $R \geq 4 \times$ cable diameter must be maintained. The cable must be routed in a way that tensile stress on the conductor or connections is prevented. The pictures are as below:

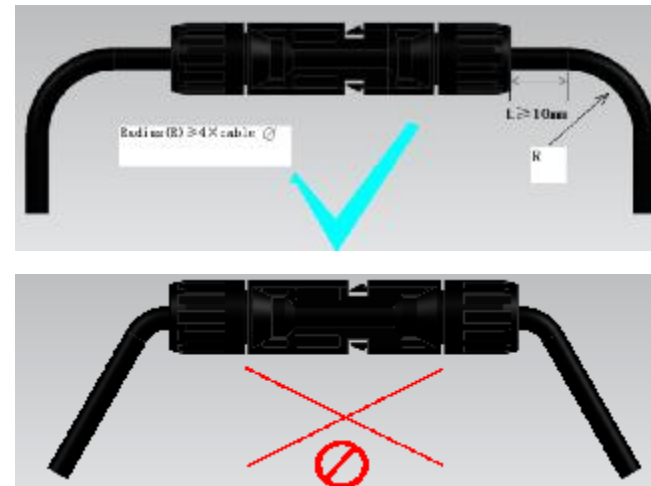



Document	Installation Manual and User Manual for BYD		Project No.	\
Code	2M SOP0007540	Edition	13	Page
				16 / 20

BYDxxxMH-36/MHK-36	≤25
--------------------	-----

According to the system voltage (1500V) of the IEC standard. Under normal conditions, a PV module is likely to experience conditions that produce more current/voltage than reported at STC. Accordingly, Isc and Voc must be multiplied by 1.25 (for C-Si or non-C-Si) we recommend the maximum number of series connected modules for each module series as stated below:

Type	The maximum number of modules in series
BYDxxxP6-18/P6K-18	≤51
BYDxxxP6-24/P6K-24	≤39
BYDxxxP6-27/P6K-27	≤34
BYDxxxP6-30/P6K-30	≤31
BYDxxxM6-30/M6K-30	≤30
BYDxxxP6-36/P6K-36	≤26
BYDxxxM6-36/M6K-36	≤24
PHK-30	≤31
PHK-36(1992)	≤26
BYDxxxMH-30/MHK-30	≤30

And the electrical characteristics are within +/- 10% of the indicated values of Isc, Voc, Pmax under STC.

Additionally, there is an equation for calculating the modules amount in one string. It also depends on the system voltage and the lowest temperature in latest 40 years. The equation is below,

$$N \times [V_{oc} [1 + b \times (T - 25)]] \leq V_{system}$$

Here: N---means the module's amount;

V_{oc}---means the module's voltage under STC;

β ---means the voltage temperature coefficient;

T---means the lowest environment temperature in latest 40 years;

V_{system}---means the system voltage of the module.

(4)For parallel connection, the current will be added up and the used connectors will be limited by the number of parallel connection. We recommended the maximum number of modules is 3. The fuse protection needs to be determined as well.

(5)To prevent the cables and the connectors from overheating, the cross section of the cables and the capacity of the connectors must be selected to suit the maximum system short circuit current. Please note that the upper limit temperature of cable is 90°C and that of the connector is as follows:



Document	Installation Manual and User Manual for BYD		Project No.	\
Code	2M SOP0007540	Edition	13	Page
				17 / 20

Connector Type	The upper limit temperature
PV-TS02 (1500V)	100°C
PV-ZH202B (1500V)	100°C

(6) There is no general limitation on the number of parallel connected modules but the number of modules is determined by system design parameters such as current or power output. Every PV array in parallel should install a protection circuit.

(7) Please refer to local laws and regulations to determine the system wires size, type and temperature. To prevent the cables and the connectors from overheating, the cross section of the cables and the capacity of the connectors must be selected to suit the maximum system short circuit current (the recommended cable cross section is 4mm² for a single module or a rated current of the connectors of more than 10A). Our module's maximum fuse rating current is 15A.



NOTE: Please note that the upper temperature limit is 90°C for cable and 100°C for the connectors. We demand the connection must be matching BYD's, otherwise BYD don't responsible for anything about performance problem caused by your action.

4. Maintenance and Care

4.1 General Maintenance

The following inspections of the modules should be carried out in regular intervals:

(1) Regularly check the mechanical installation of the module. Check the support equipment for fastness and symptoms of corrosion or other damages. Check bolts and nuts for loosening, especially the places with exposure to hard winds or at times of jolting. Ensure that the fixing is fast and fasten immediately in places with some looseness. If conditions permit the metal fittings that fasten or support the modules, such as the bolts and nuts, should be protected from corrosion. A first inspection should be carried out 12 months after installation and inspections every 10 years thereafter.

(2) Regularly check the electric wiring of the modules for reliable connection to the components of the equipment and the grounding system. Check regularly, if the value of the grounding resistance is still reaching the designated requirement, If connections are not fast, fasten them by soldering. After a thunderstorm or before the start of the stormy season check the convergence box and the lightning protection systems installed inside the equipment for loss of function and change them immediately if necessary.

(3) Check cables, connectors and joints for current leakages and deal with it, in order to prevent leakage currents caused by rainy or



Document	Installation Manual and User Manual for BYD		Project No.	\	
Code	2M SOP0007540	Edition	13	Page	18 / 20

snowy weather when checking the wiring, people must take insulation equipment (such as tools and gloves etc.) with them and avoid touching the bare parts of connectors or joints with bare hand, Check the system for loosen parts of the connectors and fasten where necessary to ensure good contact. Wipe the dust from the equipment regularly to keep it clean.

(4) If the module appears in need of repair, the surface of the module should be covered with fabric or other material. There is a danger of high voltage, if the sun ray directly hit the module.



CAUTION: *If you come across loose connectors, please contact Supplier or Maintenance and let them carry out maintenance and care.*

4.2 Module Cleaning

Excess dirt and dust accumulating on the glass surface of the module can reduce its power output. Therefore BYD recommends periodic cleaning of PV modules especially during times when the modules do not have the expected power output. The cleaning process must be implemented after the PV modules are disconnected and cooled, and after cleaning PV modules must ensure dry ,next it are connected. Non-professional authorized personnel are not allowed to clean modules, and make sure they have appropriate safety equipment for aerial work and the risk consciousness of high altitude work. Please

check the glass surface of the module for cracks and damages before cleaning. If there are already cracks on the module, please do not clean but inform the installer or maintenance service provider. Do not wear metal accessories like a watch or jewelry during cleaning PV modules, avoid the broken of modules.

4.2.1 Module Cleaning Condition

The cleaning works of PV module should be carried out at morning, evening, overcast sky or irradiance less than 200W/m². The use of cold water to clean a PV module heated up sunshine might cause cracks in the glass cover of the module, so strictly forbidden proceed cleaning work during the noon or a strong period of sunlight.

4.2.2 Module Cleaning Method

Module cleaning method divided into general clean and washing clean.

1. General Clean

(1) To the attachment which can easy to clean like dry dust, leaves on the PV module surface, cleaner can use dry and professional mop or soft cloth to clean.

(2) To the attachment which are not easy to clean like mud, birds droppings, sticky stuff on the PV module surface, cleaner can use scraper or gauze to wipe, but avoid using hard material, to prevent



Document	Installation Manual and User Manual for BYD		Project No.	\	
Code	2M SOP0007540	Edition	13	Page	19 / 20

destroy glass surface. Use cleaning effect to judge whether clean or not.

2. Washing Clean

(1) To the inorganic compound like wet dust which are not easy to clean on the PV modules surface, cleaner can carry out general clean (2) first, then use clean water which pressure less than 500KPa to washing, finally, use clean gauze wipe the waterlogging. To avoid cell micro crack or module broken, cleaner must attention the water pressure should not too large.

(2) To the organic like animal corpse (such as mosquitoes and flies), dung or plant sap which are closely attach to the glass surface, cleaner can carry out general clean (2) first, then use clean water which pressure less than 5MPa to washing meanwhile match up professional cleaner like soft soap water or neutral disinfectant (such like alcohol, glass cleaner and so on) to clean this part alone, pay attention to avoid use strong chemical or grinding cleaner and disinfectant (like laundry detergent, alkaline detergent, cleanser essence, etc.). When it is necessary to use the soft sponge or cotton but can't wipe the components or apply gravity on the component.

3. Matters Attention

(1) It is forbidden to use bareness fingers or hand without gloves touch or deal with modules glass surface. Use clean gloves can avoid fingerprint or other dirt stay on the glass.

(2) It is forbidden to use metal tools like knife, blade, cleaning wire

or other grind material.

(3) It is forbidden to use grind powder, grind detergent, polished machine, sodium hydroxide, benzene, nitro diluent, acid, alkali and other chemical material.

(4) It is not suggested to use water which contain much mineral substance, for the mineral substance will deposit on the glass surface when the water evaporate.

(5) If it is necessary to clean the snow to improve the power output, please use brush clean the snow gently. But don't try to clean the freeze snow or ice.

4.2.3 Security Management

1. Before module cleaning, staff should check whether there are records of abnormal output in the monitoring recording, analysis whether caused by leakage current or not, and check whether exist damage or sticky on the modules' connection and related electrical components. There should use test pencil to check modules' frame, support, tempering glass surface, to eliminate leakage potential, ensure personal safety.

2. There are many sharp corner on modules frame and support, cleaner should wear appropriate protective clothing and wear helmets to avoid causing injury. It is necessary to prohibit the emergence of hook, belt, threads, and other components that are easy to cause obstruction in clothing or tools.

3. It is forbidden to tread PV modules, guide rail support, cable tray



Document	Installation Manual and User Manual for BYD		Project No.	\	
Code	2M SOP0007540	Edition	13	Page	20 / 20

or any other PV system equipment or any way force on modules and support.

4. It is forbidden to use hard and sharp tools or corrode solvent or organic solvent wipe module, it is forbidden to spray the cleaning water to the module junction box, cable tray, combiner box and so on. To avoid module micro crack, cleaner must attention the cleaning equipment's pressure which should be controlled in a range.

5. It is forbidden to clean modules in windy, heavy rain, thunderstorms, heavy snow. Avoid rinse in winter, to prevent freeze in low temperature cause dirty accumulate; at the same time, don't use cold water rinse when module surface hot.

6. When cleaning, staff are forbidden stand at distance less than 1 meter from the roof edge. Tools and sundries are not allowed to be thrown down, bring back after work.

5. Claim

As the adherence to this manual and the conditions or methods of installation, operation, use and maintenance of photovoltaic (PV) products are beyond BYD's control. BYD does not accept responsibility and expressly disclaims liability for any loss, damage, or expense arising out of or in any way connected with incorrect installation, operation, use or maintenance.

The information in this manual is based on BYD's knowledge and experience and is believed to be reliable. This manual provides reference only, and consumers are free to choose an appropriate way of installation according to place and environment.

BYD reserves the right to change the manuals, PV products, specifications and product information sheets without prior notice.



NOTE: A note provides information about installation, operation, or maintenance of the module that is important to know, but it is not necessarily hazardous.



CAUTION: A caution message indicates a potential threat to minor injury, or alerts against behavior that can lead to property damage.



DANGER: A danger message indicates a hazard in the immediate area which, if not avoided, can result in death or serious injury.